



PST50-8 PST50-12 PST50-9 PST50-14
PST150-9 PST150-12 PST50-4
MANUAL



HUZHOU DAI XI ZHENHUA TECHNOLOGY TRADE CO., Ltd.

PACIFIC RIM INT'L WEST INC.

PREFACE

To my dear customers:

We'd like express our gratitude for your choosing ZHENGHUA motorcycles.

ZHENGHUA motorcycles are sold overseas for its reasonable design, advanced technique and beautiful appearance. The quality of our products enjoys good reputation among new and old customers.

As an ideal foot-substitute and transport tool, ZHENGHUA motorcycles will offer you more convenience to your work and bring more pleasure to your life.

The manual contains the right and simple way to use and maintain the motorcycles. Please read carefully before using it. It is very helpful for your

using and maintenance. In order to make your motorcycle work in good condition, please use the initial fitting of ZHENGHUA factory. If you have any question and difficulty in the process of using our motorcycles, please contact us in time. We would supply you with high-efficiency and quality service.

Your sincere suggestion for ZHENGHUA motorcycles are warmly welcomed.

**This product has been patented in the
United States**

**Any copying or counterfeiting would be
strictly forbidden.**

Patent No: _____

IMPORTANT NOTES

Tips of motorcycle brake-in

The first 1600 km is the most important in the life of your motorcycle. Proper break-in operation during this time will ensure maximum life and performance of your new motorcycle. Zhenhua motorcycle parts are made of high quality materials, and machined precisely, so the right way of break-in can ensure every part being absolutely smooth and precise. It is most important that you should avoid operating the engine in the manner which could cause the engine parts to excessive heat such as running at very high speed for a long time.

Please refer to “break-in” section for specific break-in recommendation.

SPECIAL

WARNING/WARNING/CAUTION/NOTE

Please read this manual and follow its instruction carefully. To emphasize special information, the words “WARNING”, “CAUTION” and “NOTE” carry special meaning and should be carefully reviewed.

SPECIAL WARNING!

The word that the driver must comply with the safety issues, otherwise they will endanger themselves and others..

WARNING!

The personal safety of the rider may be involved; disregarding this information could result in casualty to the rider.

CAUTION:

The word representation of those that must comply with the use or operation notes, to avoid damage to motorcycle.

CAUTION:

This provides special information to make maintenance easier or important instructions clearer

SPECIAL WARNING

- 1. Please learn how to drive in regular driving school and get the drive license before driving.**
- 2. You must comply with local laws and regulations of the traffic. Driving after drink is strictly prohibited, use of cell phone or smoking in driving process is prohibited neither.**
- 3. Never lend your motorcycle to anybody that don't drive nor no drive license.**
- 4. Never drive before read this manual.**
- 5. Don't modify by yourself, any consequence should be born by your self.**
- 6. Not be used for purposes other than riding**
- 7. Never release handle in driving**
- 8. Avoid sharp turn. Please drive slowly when turn, especially rainy and snowy. No speed over 5mph when turning, neither no speed over 3mph when reversing.**
- 9. Once there are exceptions, please do not ride, please contact our dealer for maintenance.**
- 10. Prohibited without wearing safety helmets, goggles and safety services to motorists.**

11. Please take a good run-in , and regularly check whether the bolts screws loosening.

Otherwise, the frame will affect the strength and driving safety.

12. Don't park your motorcycle near the fire or smoke.

13. In order to prevent fire, don't charge the fuel when motor running, not to excess fuel in the start state

14. Don't touch the engine and exhaust when motor running or just stopped. Prevent the inflammable close to the engine.

15. Don't drive on the highway

16. Don't lay on the glove box when driving.

17. Carefully check every time before drive.

1) If all screws tighten enough.

2) If the oil, brake, tire pressure, lights works properly.

3) Carefully check the water cooler if your motorcycle have it. Check all the joint for leakage after start.

The engine will be burned immediately if lack of oil and cooling fluid. The importer and dealer born no response if your counter the special warning above.

TABLE OF CONTENTS

CONSUMER INSTRUCTION.....	8	TOOLS.....	37
PARTS LOCATION.....	11	STORAGE BATTERY.....	37
OPERATING	19	AIR CLEANER.....	38
KEY.....	19	SPARK PLUG.....	39
IGNITION SWITCH.....	19	ENGINE OIL.....	39
FUEL CAP.....	19	CARBURETOR.....	41
DASHBOARD.....	20	DRIVE CHAIN.....	42
LEFT、 RIGHT HANDLEBAR.....	21	BRAKES.....	43
FUEL COCK.....	23	REAR BRAKE LIGHT SWITCH.....	45
REAR SHOCK ABSORDER.....	24	TYRE.....	45
REAR DIFFERENTIAL GEAR.....	24	LIGHT CHANGING.....	47
FUEL & ENGINE OIL RECOMMENDATIONS...	26	INSPECTION AND MAINTENANCE.....	48
BREAK-IN FOR A NEW MOTERCYCLE.....	26	CHEANING STORAGE GUIDE	49
INSPECTION BEFORE RIDING.....	31		
RIDING ESSENTIALS.....	32		
STARTING THE ENGINE.....	32		
INSPECTION AND MAINTENANCE.....	35		

CONSUMER INFORMATION

PRECAUTIONS ABOUT ADDING ACCESSORIES AND PREPARATION BEFORE RIDING

You may buy all kinds of accessories to add your Zhenhua motorcycle, but unnecessary and unsuitable accessories would invite trouble for your riding. It is impossible for Zhenhua to check the quality of every accessory in the market, but our service station can supply you with high quality accessories and can equip properly for you.

Please choose and add accessories carefully and you should comply with the following instruction:

- (1) Please choose the genius parts from the original factory. The installation should be properly and fasten. The wrong installation would cause bad influence to the

performance and safety.

- (2) Checking the off-ground height of accessory and the angle, the improper adding will make the two aspects unsafe, also the accessory adding should not hinder parking, diverting and other manipulating.
- (3) Customize the motorcycle by your self is not recommended, especially the parts that effective to your drive safety.
- (4) Wind guard, backrest, and saddle boxes are counter wind parts that cause the motorcycle unbalance. Especially when the wind from side and meet the huge vehicle. Unfastened accessories or bad design equipment will cause the dangerous, so you have to choose the safe accessories and fix properly.
- (5) Some accessory adding may cause the seat

of the driver diverting from the original position, this doesn't only restrict the range of driver's action, but limit his skill of operating as well.

- (6) The extra electric fitting may weight the original electric system, on some over-weighted conditions, the accessory may be destroyed or the power may be cut off. **All the fitness should be fasten, loosen of the parts is the directly cause of the damage and dangerous.**

SAFE RIDING RULES

Motorcycle riding is great fun and an exciting sport. Motorcycle riding also requires that some extra precautions be taken to ensure the safety of the rider. The driver should comply with the following rules:

WEAR A HELMET

Motorcycle safety equipment starts with a good

quality helmet. One of the most serious injuries that can happen is a head injury. **ALWAYS** wear a properly approved helmet. You should also wear suitable eye protection.

DRESS

The slack and curious clothing will make you uncomfortable and unsafe, so please choose the good quality and tight clothing.

REVIEW THE OWNERS MANUAL

Review thoroughly this owner's manual to familiarize your motorcycle construction and basic characteristics, then make a pre-ride inspection as per "inspection before riding" and perform any needed adjustments making the parts in best condition to ensure the safety of the rider. **In order to keep the driver and passenger's safe.**

FAMILIARIZE YOURSELF WITH THE MOTORCYCLE

Your riding skill and your mechanical knowledge form the foundation for the safe riding practice. We suggest that you practise riding your motorcycle in a non-traffic situation without obstacles until you are thoroughly familiar with your machine.

KNOW YOUR OWN SCOPE OF SKILL

The riding should be always controlled in the scope of your riding skill, never try the risky riding.

PAY ATTENTION TO SOME SPECIAL CONDITIONS

Pay more attention during the bad weather days. Riding on bad weather days, especially wet ones, requires extra caution. Breaking distance double on a rainy day. You should ride the motorcycle slowly and keep a sufficient brake distance.

Take extreme caution at railway crossings and on metal gratings and bridges. Whenever in doubt about

road conditions, slow down!

PRECAUTIONS ABOUT THE RIDING ACCIDENT

Many motorcycle accidents happen during motorcycle turning or other vehicle turning in front of motorcycle, therefore, it is best to wear bright or reflective clothing and take care while turning. You should turn on the front and rear light to remind other drivers. Never drive your motorcycle into other driver's blind spot.

MODIFICATION

It is dangerous and illegal to modify the equipment or remove the parts from the original equipment, so all the equipment should in comply with the specification.

SERIAL NUMBER LOCATION

The frame and engine serial numbers are used to register the motorcycle; it is also useful for the Zhenhua maintenance station.



The frame number ①

The engine number ② is on the bottom of the engine center.

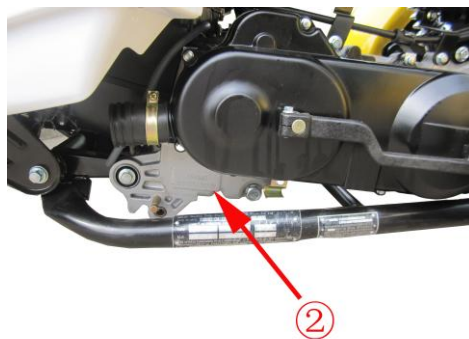

Please fill out the form with the correct number :

The frame number:

The engine number:

PARTS LOCATION

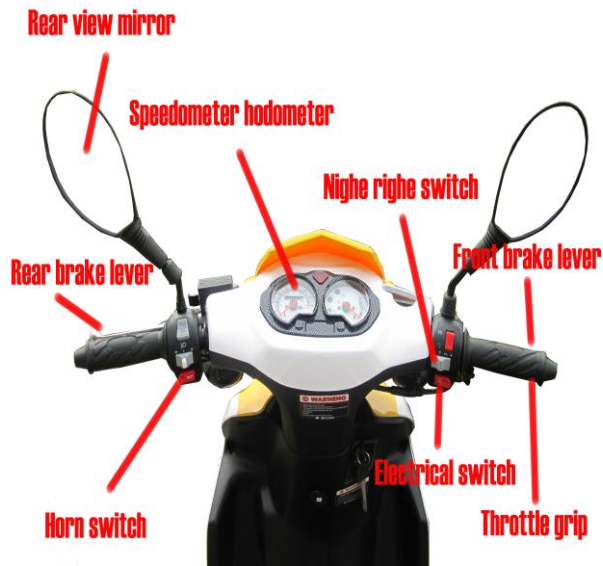

PST50S-8

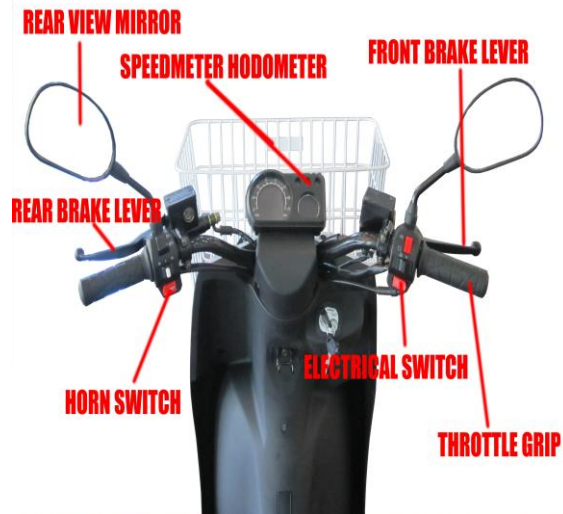

PST50S-9R

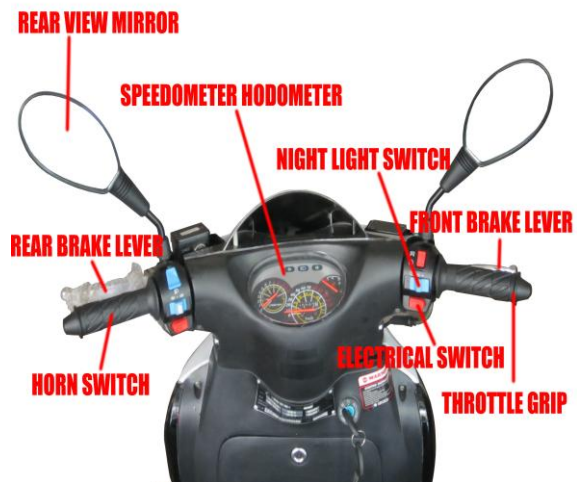

PST50S-12



PST50S-8



PST50S-8



PST50S-9R



PST50S-9R



PST50S-12



PST50S-12

STEERING SYSTEM

KEY there are two keys to the motorcycle. The keys can control sparking switch, steering- lock, cap lock and helmet-pole lock.

Please keep one of two as backup

SPARK SWITCH



There are two positions:

 **“IGNITION” position**

When all the electricity working, you may ignite at any time, the key can not be pulled out

 **“OFF” position**

When all the electricity was cut off and the engine could not be opened up, the key can be pulled out.

PUSH

The seat could be open when key in this position



Steering lock

In this position, and rotate to the left end will lock the steering. Don't forget to remove the key.

Fuel tank cap



PST50S-8



PST50S-9R



PST50S-12

(1)Fuel tank cap

When you want to open the cap, insert the key into the hole on the cap and turn on clockwise, the cap can be opened. **When close, push the cap till the lock sound, then take out the key.**

The fuel tank capacity is 4.5 L, in which the reserve capacity is 0.6-1.6 L.

WARNING!

Do not overfill the fuel tank to prevent the fire caused by fuel overflowing to hot engine.

Never refuel near an open fire.

Dashboard



PST50S-8



PST50S-9R



PST50S-12

Speedometer ①

The speedometer is used to show how many kilometers per hour the running speed is. **The max speed on the meter is not the top speed this motorcycle could reach. The real speed will not exceed the max speed on the meter.**

The odometer is used to show how many kilometers the motorcycle has driven.

Warning!

The max speed on the meter does not equal to the speed limit in your country, please drive under your country's law and regulation.

Fuel gauge ③

Fuel meter shows how many fuel remain in your tank.



Turning indicator④

Turning indicator shows the turn direction .

LEFT HANDLEBAR SYSTEM



VARIABLE SWITCH ①

When you riding at night, push the button on “” position, on condition that the button of right light is on “” position, the high beam and the night beam can be lighted up. Put the button on “” position, the dipped headlight can be lighted up. If these lights are unnecessary, push the button of right light on “ ” position.

LEFT-RIGHT TURNING SIGNAL BUTTON

Turn the “←” button left , the left signal can be

lighted up . Turn the “→” button right, the right signal can be lighted up . The indicator on the dashboard can also be lighted up. If you want to turn down the signal, press the button down.

HORN BUTTON③ “”

Press down the button, the horn blares.

RIGHT STEERING SYSTEM



ENGINE STOP SWITCH①

Press the “” the electricity can be connected and the engine can work. It is of a emergency stop

switch. If the button is on “  ” position, the engine can not work, the starting electricity is totally cut off

FRONT BRAKE LEVER②

WARNING

SENT THE SIGNAL BEFORE SHIFTING ROAD AND TURN DOWN THE SIGNAL IF FINISHED

Pulling back the lever will break the front wheel and the rear brake light will be lighted up.

Warning !

Don't use the front brake in driving, especially in high speed or turning. It's very dangerous. Please slightly use both front and rear brake and keep the safety distance. At least 200m in rainy or snowy

THROTTLE GRIP③

The throttle grip is used to control the engine speed. Twist the throttle grip toward yourself to increase the engine speed. Turn it away from yourself to decrease the engine speed. Turn it away from yourself to decrease the engine speed.

LIGHT BUTTON④

“  ”: in this position, the headlights, backlights, parking lights and dashboard lights are lighted up.

“  ”: in this position, the backlights, parking lights and dashboard lights are lighted up.

“  ”: in this position, the headlights, backlights, parking lights and dashboard lights are powered off.

ENGINE BUTTON⑤“ ”

Press this button can power on the electricity of motor. If the button of the motor is in the position of “  ”, the motor can not be powered on, the gear must in neutral before the motor is powered

CAUTIONS

TOO MUCH DISCHARGE WILL MAKE THE CIRCUIT AND MOTOR TOO HOT, POWER ON THE MOTOR FOR NO MORE THAN FIVE SECOND ONCE A TIME. AFTER SEVERAL FAILS OF OPERATING, YOU SHOULD CHECK THE FUELING SYSTEM AND STARTING CIRCUIT.

REAR SHOCK ABSORBER

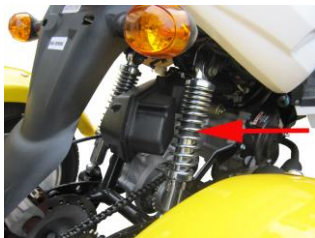

This shock designed for road use. When use on the uneven road, please drive slowly.

Differential Gear



PST50S-8



PST50S-9R



PST50S-12

The differential gear use to transmit the power, meanwhile make the 2 wheel rotate in different speed. In order to keep the wheel in good touch with the ground when turning.

**The differential gear is patented in US,
Patent No. _____**

Caution!

**We have 2 models of differential gear.
Whatever differential you use, please change
the oil at 1600km also clean the gear box.**

**◦ Inspect the bearing and gears①. Clean
and fix as previews if they are no damaged**

**◦ Check the gear box②. It's necessary to
change it if the box is crack**

**.check all the bolt and screws③ after
assembly, recheck for leakage after several
km driving**

**◦ Please pay more attention to this
differential gear when you driving, feel free to
contact our dealer if there is any problem with**

Diagram for the differential gear

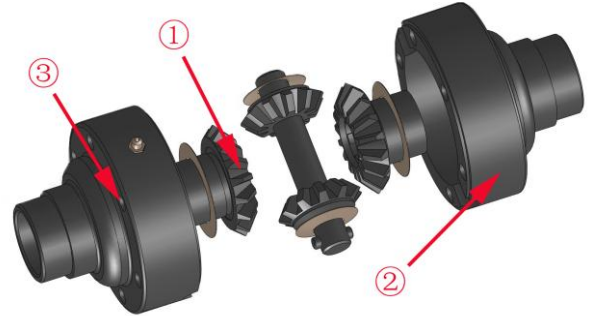

FUEL AND ENGINE OIL RECOMMENDATION

FUEL

Please use unleaded [GB17930-1999] petrol with a octane number of 91 or high. Using the unleaded high quality oil can prolong the life of your motorcycle and can also contribute to environmental protection.

ENGINE OIL

The engine oil used in this motorcycle conforms to Chinese National Standards GB11121-95 and American National Standards SAEJ183E80. Please use good quality 10W/40QE engine oil. Zhenhua special engine oil, band four-strobe 15w/40 engine oil, is strongly recommended to use. Mixed oil with different brand is unallowable.

Choose the different engine oil according to the

various area and climate.

The following items are the different engine oil use in sphere of application.

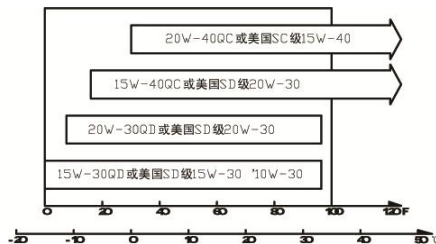

Rack

The rack located at the rear of the motorcycle, use to pull some trailer or luggage.

Warning !

Please follow the law and regulation of the usage of the rack in your country. The recommend max trailer capacity is 40kg, the speed should don't over 30mph and 5mph when turning.

BREAK-IN FOR A NEW MOTORCYCLE

The forward explains how important the proper running-in is to achieve maximum life and performance of your new motorcycle. The following guidelines explain proper running-in procedures.

The following table shows the maximum recommended throttle opening during the break-in period:

Initial 800 km	less than 1/2
To 1600km	less than 2/3

VARY THE ENGINE SPEED

The engine speed should be varied and not hold at a constant speed. This allows the parts to be “loaded” with pressure, and then unloaded, allowing the parts to cool. This aids the mating process of the parts.

It is essential that some stress be placed on the engine components during break-in to ensure this mating process. Do not, though, apply excessive load on the engine.

AVOID CONSTANT LOW SPEED

Operating the engine at constant low speed (light load) for a long time can cause parts to graze and not fit close to each other. Allow the engine to accelerate freely through the gears, without exceeding the recommended maximum limits. Do not, however, use full throttle for the first 1600 km.

ALLOW THE ENGINE OIL TO CIRCULATE BEFORE RIDING

Allow sufficient idling time after warm or cold engine start up before applying load or reviving the engine. This allows time for the lubricating oil to reach all critical engine components.

PERFORM THE NECESSARY PERIODIC MAINTENANCE

The initial 1000 km service is the most important to your motorcycle. During break-in all of the

engine components will fit close to each other sufficiently. All adjustments will be restored, all fasteners will be tightened, and the dirty oil will be replaced.

Timely service during the 1000km service will ensure optimum service life and the best performance of the engine.

Perform the 1000km maintenance will extend the life time of the engine. And keep it works in good condition.

WARNING

Maintenance for 1000km should be according to the “maintenance planning” in the specification. Pay more attention to the “NOTE”& “WARNING”.

WHAT TO CHECK	IMPORTANT ITEMS
Steering	1) Smoothness 2) No restriction of movement. 3) No play or looseness
Brakes	1) the fluid level in brake fluid reservoir should be higher than the “LOWER” lever limit. 2) Brake shoes to be within the wear limit.3) No dragging (sponge status)
Tires	1) proper pressure. 2) Adequate tread depth. 3) No cracks or cuts on the tire surface.
Fuel reservation	Enough fuel for the planned distance of operation.
light	Operating all the lights ——front light, rear light, brake light, light of dashboard, turning light.
indicator	
Horn button	The function is in normal
Engine oil	proper oil level
throttle	1) Correct play in the throttle cable 2) Smooth operation
Drive chain	1) Proper tightness. 2) Proper lubrication.3) degree of wear
Assemble tautness	Fasten the lax parts

RIDING ESSENTIALS

WARNING

- 1: if you ride this motorcycle for the first time, we suggest that you practise riding your motorcycle in a non-traffic situation without obstacles until you are thoroughly familiar with your machine.
- 2: Do not drive your machine with one hand. Do not drive your without hand in any conditions.
- 3: Do not brake hardly while turning, slow down while turning.
- 4: You should ride the motorcycle slowly and keep a sufficient brake distance in rainy and smooth road.
- 5: Observe the traffic regulation and limit the speed.

STARTING THE ENGINE



WARNING

Never start the engine in the narrow position to avoiding danger. **Don't press the start button after engine started, it will cause the damage to the engine.**

When the engine is “COLD”, the procedure is as

follow:

- 1) Turn the fuel cock to “ON” position
- 2) Insert the key into the lock of electric switch and turn to “ON” position
- 3) The throttle opening should be less than 1/8, press the kick starter lever. As soon as the engine started, release the kick starter lever quickly.

NOTES:

Do not race your engine when you are not riding. A long time race will make your engine too hot and destroy the interior parts.

WARNING:

Never start the motor for five seconds one time, because too much discharge will make the electricity and starting motor too hot. Try several times; check the oil supply system and electricity starting system if still fails.

NOTES:

In some cold area, push the electric button on “OFF” position before starting the machine, closed down the chock valve, open the throttle then press the starting lever for several times to make the engine easy to start.

NOTES:

Preview the related riding knowledge before riding.

WARNING

When your motorcycle is speeding up, keep a long distant before braking. In order to have enough time to brake, you should consider the distant between you and vehicles.

The drivers with no experience are used to brake by the rear brake; this will increase the abrasion of the rear brake system.

It is dangerous to stop your motorcycle by only using the front or rear brake, this method will make your motorcycle out of control for the skidding. Take more care and use the brake system slightly in the rainy and smooth road. To brake sharply in the rugged and smooth road will make your out of control.

INSPECTION AND MAINTENANCE

The following chart indicated the intervals between

periodic services in kilometers and months. As the end of each interval, be sure to inspect, check, lubricate and service as instructed.

WARNING:

The periodic checking and maintenance to your motorcycle is very necessary and important to ensure your safety and prolong your motorcycle service life.

NOTES:

You will change one or several parts in the period of checking and maintenance. We suggest that you use the authorized Zhenhua parts. Mechanic experts or experienced repairman, we suggest that you have the item with*serviced by the authorized and qualified service mechanic. For the item without* you may have it inspected or repaired by yourself.

MAINTENANCE CHART

Item	Period	1000	3000	8000
	Month	5	20	40
*Exhaust pipe bolts, cylinder head nuts		T	T	T
*Crankcase drive chain		CH	CH	CH
Air cleaner		—	C	C
*Valve clearance		Check every 12000 km		
Spark plug		—	C	R
*Fuel line		—	C	R
		*Replace every 4 years		
Engine oil		R	R	R
Oil filter		R	—	R
Carburetor		CH	CH	CH
Drive chain		CH	CH	CH
		Apply oil every 1000 km		
*Brakes		CH	CH	CH
Tires		—	CH	CH
*Steering		CH	—	CH
*Front fork		—	—	CH
*Rear suspension		—	—	CH
*Chassis bolts and nut		T	T	T

TOOL

There is a set of tool with the motorcycle for your inspection

ACCUMULATOR

Open the seat, the accumulator can be seeing.

NOTES

The voltage of accumulator is 12v without liquid inspection and watering.

NOTES

- 1) In order to avoid dangerous, do not open the sealed cap at any time.
- 2) The condition of electrification can be inspected by the voltmeter.

(The normal voltage is more than 12.8v)

CAUTIONS:

Although the accumulator is totally sealed, the improper operation will invite trouble.

Please observe the following items:

- 1) Fasten the accumulator, never make it loosen or make the cathode and anode opposite to each other.
- 2) Never place it in the high-temperature or smoke and flame location.
- 3) If your eyes or skin is stained with vitriol, clean it with water or go to doctor as soon as possible.

THE METHOD OF CHARGING WITH SEALED ACCUMULATOR FOR YOUR MOTORCYCLE:

- 1) To energize after half a year's storage.
- 2) To energize as the following method.
Constant-voltage charging by current limiting, the charging voltage is between 13.8v and 14.5v, the current limiting is between 1.5A and 2.5A, the charging time is between 9 and 12 hours.

NOTES

The red line is connecting anode and the black line is connecting cathode. The opposite connecting will destroy the charging system and the accumulator.

AIR CLEANER

The air cleaner filter used in this motorcycle is a polyurethane foam filter. If the filter has become clogged with dust, intake resistance will increase with a resultant decrease in power output and increase in fuel consumption due to richer mixture. Clean the air cleaner filter periodically.

CAUTION:

If driving under dusty conditions, the filter must be cleaned and replaced more frequently.

Maintenance

1. Remove the left cover
2. loosen the screw, take the air filter out
3. Remove the bracket and foam filter. Clean in the detergent then dry it.
4. Dip into the oil and press to remove the over oil.
A Incombustible detergent B oil
5. Install air filter and check for the hermetic

SPARK PLUG

We suggest you can use the qualified parts-
NGK CR6HSA

1. Pull out the spark cap
2. Remove the spark plug with a plug wrench and clean all the dusty on the bottom.

Remove the carbon deposits from the spark plug with a small wire brush or a spark plug cleaning

machine. Readjust the spark plug gap to 0.6-0.8 mm by using a spark plug gap thickness gauge if it is necessary. The spark plug should be replaced periodically.

The procedure of installing spark plug is opposite to take down it, please make sure that the washer is connecting to the spark plug.

NOTES:

- 1) Do not make the spark plug too fastened for fear of destroying the screw thread. Never make the impurities come into the engine through spark plug hole when taking down the spark plug.
- 2) The spark plug in this motorcycle is elaborate selected and can meet most working. If the color of spark plug is quite different from the standard plug, you'd better contact with the Zhenhua dealer. For the improper spark plug will effect the engine's working.
- 3) Use the spark plug specified on the VECI label or will invite trouble for your operating, so you'd better contact with the Zhenhua dealer before choosing it.

ENGINE OIL

Using a good quality engine oil and periodical replacement of engine oil will extend your engine's life. Check engine oil level daily and replace engine oil periodically are two most important tasks to be carried out for maintenance items.

WARNING

To avoid unnecessary hurt when the fuel and engine oil was heated.

CHECKING ENGINE OIL LEVEL

Checking the oil level after the engine stopped working for several minutes, the motorcycle should be placed on the plain ground. Insert the dipstick ① until it seats, but not screw it in. the oil should be between the upper lever mark ② and the lower lever mark ③. If necessary, add the recommended oil until

it reaches the upper level mark, do not overfill.

REPLACING ENGINE OIL

The engine oil replacement should be carried out when the engine is warm, when replacing the engine oil, support your motorcycle with side stand to facilitate draining the oil fully. The procedure is as follow shown:

- 1) Stand your motorcycle with side stand. Put a drain pan under the engine.
- 2) Unscrew and remove the oil drain bolt ① under the engine to drain the dirt oil.
- 3) stamp the kick starter lever for several times to drain the remaining oil.
- 4) Replace the used oil filtering net with a new one, check whether the spring and sealing washer are well installed.

5) Pour 0.8L recommended oil into the engine. Start the engine, let it run at idle speed for 2-3 minutes, shut off the engine and wait for a minute, check whether the oil is at upper level mark. If the oil level is below the upper level mark, add the oil until it reaches the upper level mark.

NOTES:

- 1) Check oil filler and oil drain bolt carefully to avoid dripping.
- 2) Engine oil should be replaced frequently when riding in dusty area.
- 3) Please use the oil which we recommend in the “**FUEL AND ENGINE OIL**” item.

CARBURETOR:

The stable function of carbureting is the basic request for a engine, the carburetor is set for the best

calibration in the factory. Do not attempt to alter its setting. There are two items of adjustment, however, under your care: the idle speed and the gap of throttle cable.

DRIVE CHAIN

We suggest that you’d better entrust Zhenghua dealer with replacement of drive chain when the chain was damaged.

WARNING!

To ensure the maximum safety, the inspection and adjustment of drive chain should be carried out before riding.

When performing the periodical check, the following state of drive chain should be checked.

- 1) Loose pins
- 2) Dry or rusty chain links or

- twisted or bonded links 3) Damaged sprocket
4) twisted or bonded links 5) excessive damage
6) incorrect adjusting chain

If the above troubles found, the sprocket may be considered to cause the damage of the chain.

Therefore the following check of the sprocket is necessary. 1) Excessive wore teeth 2) damage or frangible teeth 3) Loose pins

A dirty drive chain may not only accelerate the chain wear, but also damage the sprocket. Therefore after cleaning it with clean deterging. Smear the drive chain with special chain oil or engine oil.

drive chain adjustment

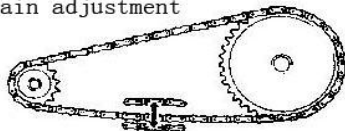

20 ~ 30mm

The drive chain should be adjusted irregularly as per the riding condition to maintain it in normal status.

WARNING!

Excessive chain slack could cause the chain to come off the sprockets and result in an accident or serious engine damage. Please check and adjust the drive chain constantly.

WARNING!

The hot silencer may hurt you, it will hot enough to hurt you even the engine was closed. In order to avoid scald, please inspect your drive chain after the silencer was cooled down.

NOTE:

Check the front and rear sprocket for wear when replacing the drive chain, replace the sprocket if necessary.

BRAKES

This motorcycle has hydraulic disc front and drum rear brake, and hydraulic disc front and rear brake 2 models. Brakes are items of personal safety and should be properly adjusted. We suggest that you should entrust Zhenhua dealer with this check.

BRAKE FLUID

WARNING!

The brake fluid is poisonous, if swallowed, forced to spit it. Avoid contact with skin or eyes. In case of contact, flush thoroughly with water and call a doctor if your eyes were exposed.

CAUTION:

Do not use the remained brake fluid from a unsealed container, and the brake fluid remained in the last repairing, because the used brake fluid may

absorb the water from the air influencing the performance of brake. Only DOT3 brake fluid can be used. Never make the brake fluid splash on the surface of painting and rubber.

Please check the fluid lever whether it is upward the “LOWER” level mark

The brake fluid should be added to the reservoir whenever the fluid level begins to reach the “LOWER” level mark please make the fluid upwards the “HIGHER” mark

NOTE:

Checking whether the pipe is in poor condition and whether there is enough fluid.

WARNING:

If the brake system or brake pads have to be repaired, we suggest that these repairs should be performed by your Zhenhua dealer. Zhenhua dealer knows your motorcycle better and is dedicated to your complete satisfaction.

CAUTION:

The high pressure brake is used by disc brake system. To ensure the safety, the replacement interval should not be more than that stipulated in “MAINTENANCE SCHEDULE” of this manual

When performing the periodical check, the following state of brake system should be checked.

- 1) Dripping or not
- 2) Crack tube or not
- 3) Keep the certain recovery

4) Wore brake pads

WARNING:

When the new brake pads begin to be used, don't ride your motorcycle immediately after the replacement. Apply the brake, release it. Repeat this procedures several times and allow the brake fluid to circulate normally.

TYRES

Check your tires for both wear and inflation pressure to ensure the riding safety before riding and when performing the periodic inspection.

NOTE:

This motorcycle is traffic-motorcycle. Riding on the hill road, desert, rugged road and rainy road will invite troubles. Disobeying the stipulation will cause serious dangerous.

TIRE PRESSURE

Improper tire pressure may not only hastens tire wear but also serious affects the stability of the motorcycle, over inflation may result in the reduction of the contract area between the tires and ground, which may cause side slip of motorcycle and loss of the control to the vehicle. Therefore tire pressure should be within specified range. Adjust the air pressure correctly when the tires are cold.

	Front tire:	Rear tire:
tire pressure	248.2KPa	206.9KPa
Tire Specifications	120/70-12M/C	205/50-10

Check your tire for both wear and inflation pressure to ensure the riding safety, make sure that there are no mark cut, nail and other sharp material inserting in your tire. If there is any wear status, please the Zhenhua dealer.

It is dangerous to use the wear tires; it will affect the traction, stability, steering and operating system. A new front tire should be replaced when the depth of thread is decreased below 1.6 mm.

A new rear tire should be replaced when the depth of thread is decreased below 2 mm.

WARNING:

The standard of your tires is as follows:

Front tire: 120/70-12 M/C Rear tire: 205/50-10

Improper tires will cause danger, so we strongly recommend you choose the tire from Zhenhua dealer.

Tire inflation pressure and the general tire condition are extremely important to the proper performance and a safety of the vehicle. Check your tires frequently for both wear and inflation pressure.

Replace the tire as per following stipulation.

When changing a burned bulb, the same power bulb should be meeting. If use the improper bulb, the whole electrical appliance may be destroyed and the burn will burn out. “The specification “and “electrical appliance” will give you more information for your consideration.

WARNING:

When the bulb is very hot in “ON” position, this condition will last for a short time after the button was turn off. So the bulb should be cooled down before operating.

NOTE:

Turn the igniting on “OFF” position when changing the bulb.

Check in again after finishing the bulb changing to make sure the new bulb can work well.

FUSE:

There is a fuse box beside the storage cell. The entire electrical appliance is protected by a fuse. Please check the fuse first when your motorcycle is dead. If the fuse has burned out, that may suggest the electrical appliance is overloaded or short-circuit. Please trust Zhenhua dealer for your repairing.

NOTE:

Turn the igniting button on “OFF” position before changing or inspecting fuse.

WARNING!

Do not use other standard fuse, which may destroy your engine and light.

TROUBLE-SHOOTING

If you can't start your engine, please check in as the follows steps

- 1) There is not enough fuel in the tank
- 2) Whether the fuel has flows into carburetor from fuel system.
- 3) Remove the hose from carb and open the cock to check if the fuel flows out
- 4) If the last step has been verified, please check the igniting system.
- 5) Remove the spark plug and connect high-tension lines.
- 6) Fasten the spark plug on the motorcycle. Turn the ignition switch on "ON" position and press down the

button to start it. If the ignition works well, there will be sparks between spark plug play. If there is no spark please contact Zhenhua authority repair station.

WARNING!

Don't let the spark plug to be near spark plug to be near spark plug opening aperture in cylinder head, because the fuel vapor in cylinder can ignite causing fire.

For reducing the possibility of electronic breakdown. Metal parts of spark plug should be close to the metal parts of frame without paint.

For preventing from the possibility of electronic breakdown. People should avoid processing this checking, who has heart disease or heart pacemaker.

WARNING:

Do not make the fuel flow all ground, it should be put into containers. Keep the fuel off the hot engine

and exhausting pipe. Keep away from fire or fire source or hot source while performing the test.

ENGINE IMPETUS IS NOT SUFFICIENT

1: check for fuel supply system of fuel tank.

2: check for ignition timing of ignition system.

3: check for engine idle speed.

CAUTION:

Before servicing, you are strongly recommended to contact Zhenghua authorized service center. If your motorcycle is valid in guarantee period, servicing by yourself may affect your advantage of guarantee.

CLEANING:

To protect the surface of painting, you should clean your motorcycle periodically. Check for the wear parts and the lacking of engine oil.

NOTE:

High pressure current may damage the parts of your motorcycle.

To avoid spraying the follows parts with high pressure current.

Ignition switch instrument carburetor drive chain entrance of silencer bottom of fuel tank switch of steering bar seat bottom

1) Spraying your motorcycle with clean water after finishing cleaning. Some remains of detergent may eroded the alloy parts.

NOTE:

Clean the plastics with soft cloth clean the dirty place several with clean water.

2) Start the engine and make it run for several minutes after drying the motorcycle.

3) Before start the engine again, try the brakes several times until the normal function can be shown.

WARNING:

You'd better consider the distance for braking to avoid danger after cleaning.

ALUMINUM TIRE MAINTENANCE:

The corrosion is caused when the aluminum tire gets to rocky and mud road. You'd better clean and dry it with soft cloth.

NOTE:

To avoid the unnecessary scar, never use the abrasive detergent and polishing clean your tire.

STORAGE GUIDE

Extended storage, such as for winter, requires that

you take certain steps to reduce the affects of deterioration from non-use of the motorcycle. In addition necessary repairs should be made before storing the motorcycle; otherwise these repairs may be forgotten by the time the motorcycle is removed from storage.

STORAGE

- 1: change engine oil.
- 2: drain the fuel tank and carburetor into a petrol container. Spray the inside of the fuel tank with aerosol rest-inhibiting oil. Reinstall the fuel filling cap.

CAUTION:

If storage will last more than half month, carburetor draining is very important to assure proper performance after storage.

WARNING!

Petrol is extremely flammable and is explosive under certain condition. Refuel in a well-ventilated area with the engine stopped. Do not smoke or allow flames or sparks in the area where the engine is refueled or where petrol is stored.

3: perform the following antirust procedures in cylinder inside:

Remove the spark plug cover, fix it to near plastic parts with rubberize fabric or cord, let it separated from the spark plug.

Poor a tablespoon (15-20cc) of clean engine oil into the cylinder, then cover the spark plug hole with a cloth.

Operate the kick starter several times to distribute the oil.

Reinstall the spark plug and spark plug cover.

4: discharge the storage cell and putting in the place without freezing and direct sunlight. Charge it one time per half year.

5: wash and dry the motorcycle. Wax all painted surfaces.

6: lubricate the drive chain.

7: inflate the tires to their recommended pressure.

Place the motorcycle on blocks to raise both tires off the ground.

REMOVAL FROM STORAGE

1: Uncover and clean the motorcycle. If storage has lasted more than 4 months, replace the engine oil.

2: charge the storage cell if necessary then reinstalls it on the original position.

3: drain the nebulous anti-rusting oil remained in fuel reservoir. Fill the fuel tank with fresh petrol.

4: perform all pre-ride inspection checks (refer to related contents).

Before restoring the normal riding, test ride the

motorcycle in a safe riding area from traffic if no trouble found, you can restore the normal riding.

Dear Friend,

Thanks for choosing "Zhenhua"/"ICEBEAR" motorcycle again.

Now you had fully comprehend our motorcycle, hope this manual would help you to master our vehicle and enhance your driving experience.

Any difficulty or problem in your usage of our motorcycle please carefully review our manual and inspect your motorcycle as the manual .

Especially please pay more attention on the "special warning""warning""caution""note", they are very important.

Any further problem please contact our dealer for help. Your comments or suggestions would be sincerely appreciated. long live to our friendship!